

Article number: 20058515

Description: E+G Quick-fit coupling (radial displacement)
GN 240.2-M20

Measures

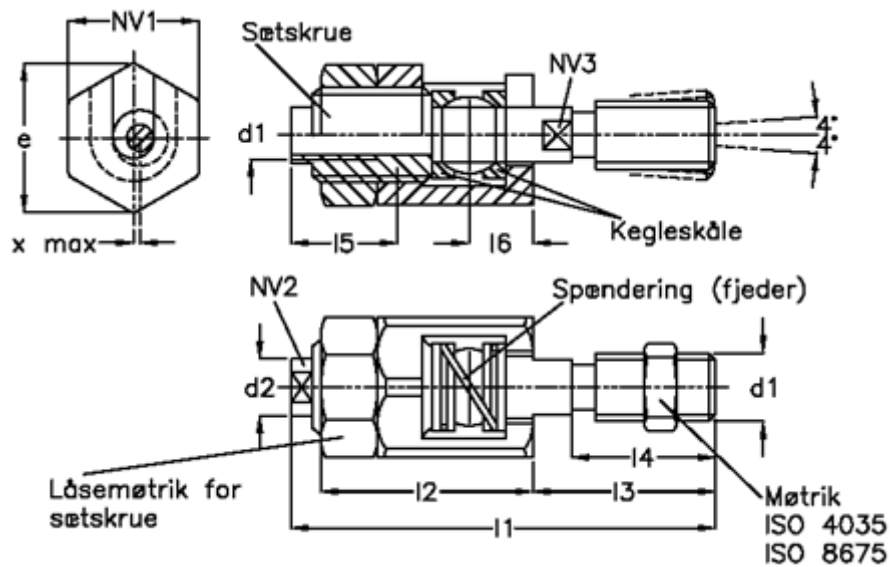

d1 = M 20x2,5	l6	= 26.0
d2 = 32.0	Max displacement	= 1.0
e = 60.0	Max push-pull strength N	= 30000
l1 = 129	NV 1	= 55
l2 = 62	NV 2	= 27
l3 = 53.0	NV 3	= 18
l4 = 42		
l5 = 34		